

EPIC[®] CONNECTORS

HBVE Series



The HBVE series inserts are high voltage inserts which are equipped with switch contacts. The switch contacts lag when inserted which prevents insertion of the connectors when the system is alive. The switching contacts interrupt the power supply to the system before the working contacts are separated.

These inserts now fit into the HBE Series housings which are standard with fixed levers.

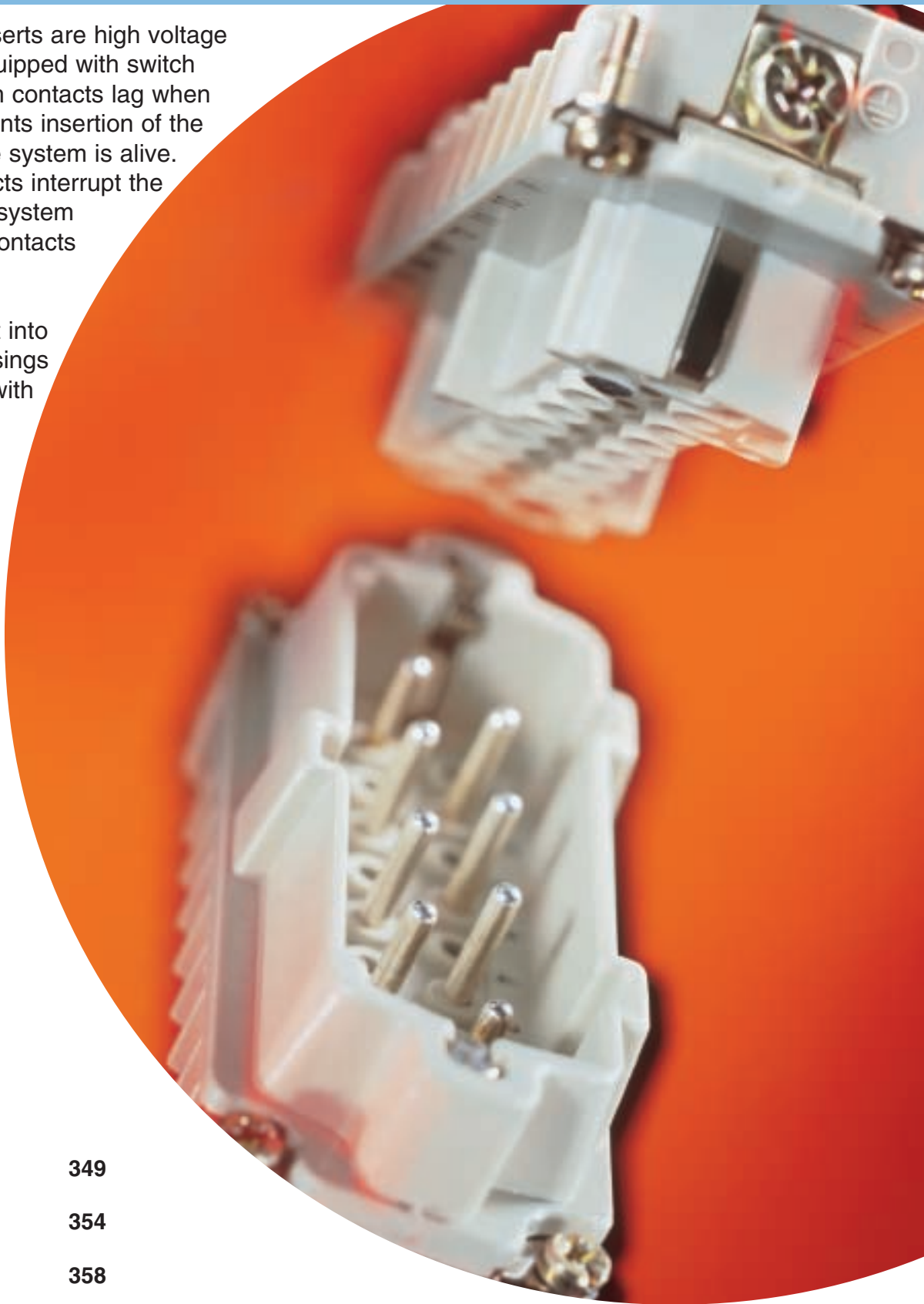

HBVE 3 Series	349
HBVE 6 Series	354
HBVE 10 Series	358

EPIC® CONNECTORS

HBVE Series



TECHNICAL DATA

Number of Contacts:	3, 6, 10 (+PE)	Termination Type:	0.5 - 2.5 mm ² AWG: 20 - 14
Rated Voltage:		Temperature Range:	-40°C to 125°C
Screw Terminated:	VDE: 630V EPIC HBVE 3 - 10 UL: 600V EPIC HBVE 3 - 10 CSA: 600V EPIC HBVE 3 - 10	Contacts:	Copper alloy, silver plated
		Contact Resistance:	<2mOhm
Cage Clamp:	VDE: 830V EPIC HBVE 3	Mating Cycles:	100 (higher mating cycles depend on the application)
Rated Current:	VDE: 16A EPIC HBVE 3 - 10 UL: 16A EPIC HBVE 3 - 10 CSA: 16A EPIC HBVE 3 - 10		
Pollution Level:	3		
Test Voltage:	6 kV		

HBVE INSERTS TECHNICAL DATA: DERATING CURVES SCREW TERMINATED

HBVE: 1.5 mm² (16 AWG)

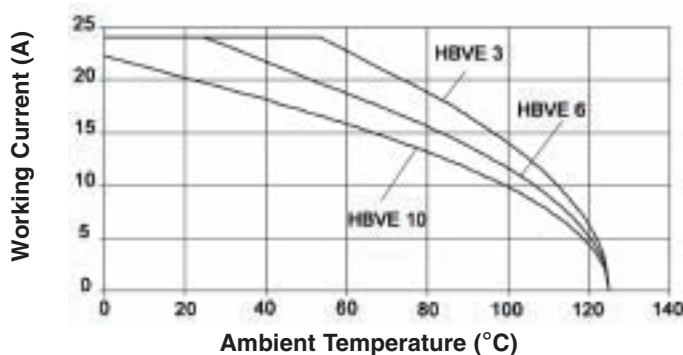

HBVE: 2.5 mm² (14 AWG)

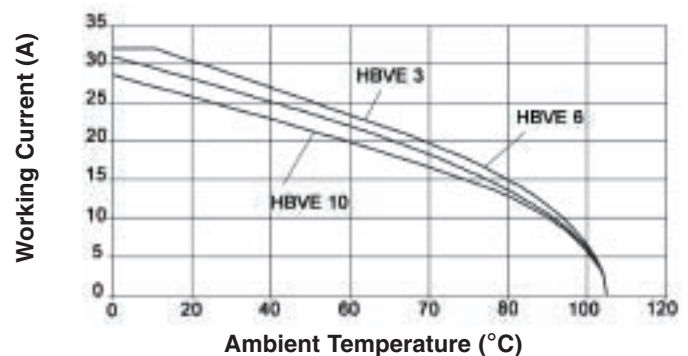

HBVE INSERTS TECHNICAL DATA: DERATING CURVES CAGE CLAMP

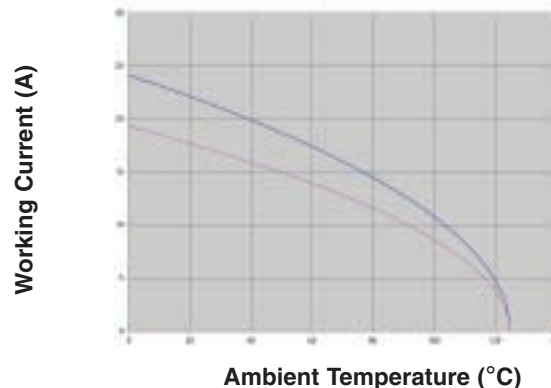

EPIC[®] CONNECTORS

HBVE Inserts: Technical Data

MATING COMPONENTS

HBVE Plugs & Receptacles fit into EPIC[®] HBE Housings. A quick reference for the mating components is shown. Diagrams are located in

the HBE Section of the catalog. Please note that metric parts are available. (See HBE Section)

Specifications: DIN 43652
Temperature Range: -40°C to +125°C

Protection class: IP65
Material: Aluminum alloy, powder coated

Standard Grey Coating (NEMA 4)

PG

NPT

METRIC



EP Black Coating (NEMA 4X)

PG

NPT

METRIC



SCREW TERMINATED INSERTS

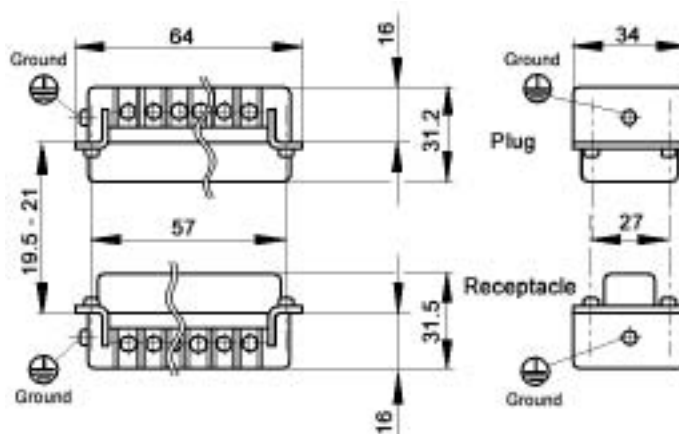

	Plug	Receptacle
Screw Termination with wire protection	10.210010	10.211010
Screw Termination without wire protection	10.210110	10.211110

SCREW TERMINATED INSERTS

View from cable side

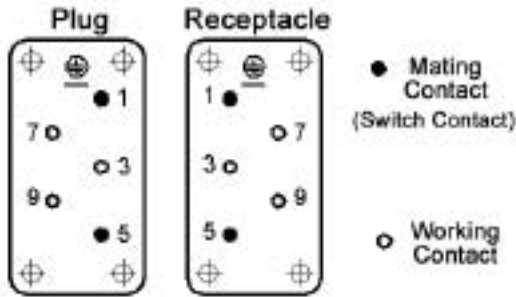

Panel Cut-Out
(Insert Only)

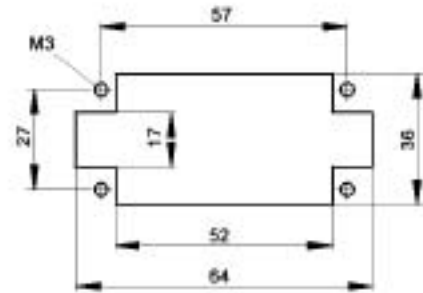

All dimensions are in mm.

HBVE 3 CAGE CLAMP INSERTS

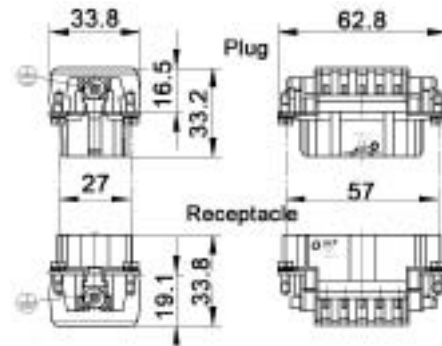
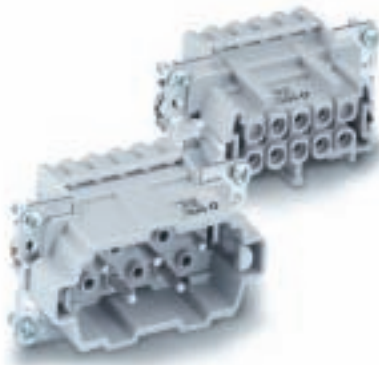

Plug	Receptacle
10.210040	10.211040

MATING COMPONENTS

HBVE 3 Plugs & Receptacles fit into the EPIC® HBE 10 Housings. Following is a quick reference for the mating components is shown. Diagrams are located in the HBE Section of the catalog (Page 283). Please note that metric parts are available.

EPIC[®] CONNECTORS

HBE 10 Housings: Single Lever on Base for HBVE 3 Inserts



HOODS



STANDARD PROFILE

Position of Cable Entry	Size of Entry		Standard Grey Coating		Black Coating (EP)	
	PG	NPT	PG Part #	NPT Part #	PG Part #	NPT Part #
Top Entry	16	1/2"	10.0409	10.0409 NP	70.0490	70.0490 NP
	21	3/4"	10.0407	10.0407 NP	70.0496	70.0496 NP
Side Entry	16	1/2"	10.0429	10.0429 NP	70.0590	70.0590 NP
	21	3/4"	10.0428	10.0428 NP	70.0596	70.0596 NP

HIGH PROFILE

Position of Cable Entry	Size of Entry		Standard Grey Coating		Black Coating (EP)	
	PG	NPT	PG Part #	NPT Part #	PG Part #	NPT Part #
Top Entry	21	3/4"	70.0442	70.0442 NP	70.0492	70.0492 NP
	29	1"	70.0444	70.0444 NP	70.0494	70.0494 NP
Side Entry	21	3/4"	70.0542	70.0542 NP	70.0592	70.0592 NP
	29	1"	70.0544	70.0544 NP	70.0594	70.0594 NP

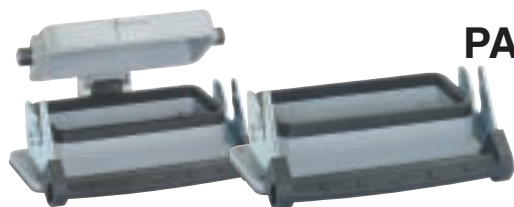

PANEL MOUNT BASES

Description	Standard Grey Coating	Black Coating (EP)
Without Dust Cover	10.0329	70.0327
With Dust Cover	10.0339	70.0337

SURFACE MOUNT BASES

STANDARD PROFILE

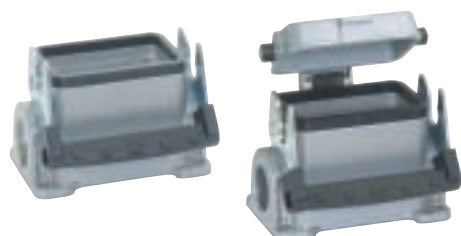

# of Entries	Size of Entry		Standard Grey Coating		Black Coating (EP)	
	PG	NPT	PG Part #	NPT Part #	PG Part #	NPT Part #
2 Entries	16	1/2"	10.0359	10.0359 NP	70.0630	70.0630 NP
1 Entry	16	1/2"	10.0349	10.0349 NP	70.0620	70.0620 NP
	21	3/4"	10.0347	10.0347 NP	-	-
2 Entries with dust cover	16	1/2"	10.0389	10.0389 NP	70.0670	70.0670 NP
	-	-	-	-	-	-
1 Entry with dust cover	16	1/2"	10.0369	10.0369 NP	70.0660	70.0660 NP
	-	-	-	-	-	-

HIGH PROFILE

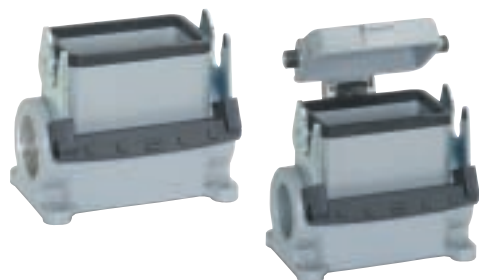

# of Entries	Size of Entry		Standard Grey Coating		Black Coating (EP)	
	PG	NPT	PG Part #	NPT Part #	PG Part #	NPT Part #
2 Entries	21	3/4"	70.0612	70.0612 NP	70.0632	70.0632 NP
	29	1"	70.0614	70.0614 NP	70.0634	70.0634 NP
1 Entry	21	3/4"	70.0602	70.0602 NP	70.0622	70.0622 NP
	29	1"	70.0604	70.0604 NP	70.0624	70.0624 NP
2 Entries with dust cover	21	3/4"	70.0652	70.0652 NP	70.0672	70.0672 NP
	29	1"	70.0654	70.0654 NP	70.0674	70.0674 NP
1 Entry with dust cover	21	3/4"	70.0642	70.0642 NP	70.0662	70.0662 NP
	29	1"	70.0644	70.0644 NP	70.0664	70.0664 NP



CABLE COUPLER HOODS

Profile	Size of Entry		Standard Grey Coating		Black Coating (EP)	
	PG	NPT	PG Part #	NPT Part #	PG Part #	NPT Part #
Standard Profile	16	1/2"	10.0469	10.0469 NP	70.0430	70.0430 NP
	21	3/4"	70.0422	70.0422 NP	70.0432	70.0432 NP
High Profile	21	3/4"	70.0424	70.0424 NP	70.0434	70.0434 NP
	29	1"	70.0426	70.0426 NP	70.0436	70.0436 NP

EPIC® CONNECTORS

HBE 10 Housings: Double Lever on Base for for HBVE 3 Inserts



HOODS



STANDARD PROFILE

Position of Cable Entry	Size of Entry		Standard Grey Coating		Black Coating (EP)	
	PG	NPT	PG Part #	NPT Part #	PG Part #	NPT Part #
Top Entry	16	1/2"	10.0400	10.0400 NP	70.0510	70.0510 NP
	21	3/4"	10.0401	10.0401 NP	70.0512	70.0512 NP
Side Entry	16	1/2"	10.0420	10.0420 NP	70.0530	70.0530 NP
	21	3/4"	10.0421	10.0421 NP	70.0532	70.0532 NP

HIGH PROFILE

Position of Cable Entry	Size of Entry		Standard Grey Coating		Black Coating (EP)	
	PG	NPT	PG Part #	NPT Part #	PG Part #	NPT Part #
Top Entry	21	3/4"	70.0504	70.0504 NP	70.0514	70.0514 NP
	29	1"	70.0506	70.0506 NP	70.0516	70.0516 NP
Side Entry	21	3/4"	70.0524	70.0524 NP	70.0534	70.0534 NP
	29	1"	70.0526	70.0526 NP	70.0536	70.0536 NP

PANEL MOUNT BASES

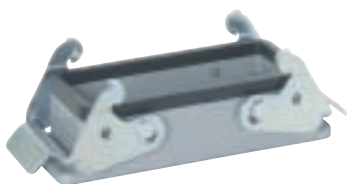

Description	Standard Grey Coating	Black Coating (EP)
Without Dust Cover	10.0320	70.0325

SURFACE MOUNT BASES



STANDARD PROFILE

# of Entries	Size of Entry		Standard Grey Coating		Black Coating (EP)	
	PG	NPT	PG Part #	NPT Part #	PG Part #	NPT Part #
2 Entries	16	1/2"	10.0350	10.0350 NP	70.0380	70.0380 NP
1 Entry	16	1/2"	10.0340	10.0340 NP	70.0370	70.0370 NP

HIGH PROFILE

# of Entries	Size of Entry		Standard Grey Coating		Black Coating (EP)	
	PG	NPT	PG Part #	NPT Part #	PG Part #	NPT Part #
2 Entries	21	3/4"	70.0362	70.0362 NP	70.0382	70.0382 NP
	29	1"	70.0364	70.0364 NP	70.0384	70.0384 NP
1 Entry	21	3/4"	70.0352	70.0352 NP	70.0372	70.0372 NP
	29	1"	70.0354	70.0354 NP	70.0374	70.0374 NP

CABLE COUPLER HOODS



Profile	Size of Entry		Standard Grey Coating		Black Coating (EP)	
	PG	NPT	PG Part #	NPT Part #	PG Part #	NPT Part #
Standard Profile	16	1/2"	10.0460	10.0460 NP	70.0410	70.0410 NP
	21	3/4"	70.0402	70.0402 NP	70.0412	70.0412 NP
High Profile	16	1/2"	70.0404	70.0404 NP	70.0414	70.0414 NP
	21	3/4"	70.0406	70.0406 NP	70.0416	70.0416 NP

EPIC[®] CONNECTORS

HBE 10 Housings: Double Levers on Hood for HBVE 3 Inserts



HOODS



STANDARD PROFILE

Position of Cable Entry	Size of Entry		Standard Grey Coating		Black Coating (EP)	
	PG	NPT	PG Part #	NPT Part #	PG Part #	NPT Part #
Top Entry	16	1/2"	10.0410	10.0410 NP	70.0560	70.0560 NP
Side Entry	16	1/2"	10.0450	10.0450 NP	70.0580	70.0580 NP

HIGH PROFILE

Position of Cable Entry	Size of Entry		Standard Grey Coating		Black Coating (EP)	
	PG	NPT	PG Part #	NPT Part #	PG Part #	NPT Part #
Top Entry	21	3/4"	70.0552	70.0552 NP	70.0562	70.0562 NP
	29	1"	70.0554	70.0554 NP	70.0564	70.0564 NP
Side Entry	21	3/4"	70.0572	70.0572 NP	70.0582	70.0582 NP
	29	1"	70.0574	70.0574 NP	70.0584	70.0584 NP

PANEL MOUNT BASES



Description	Standard Grey Coating	Black Coating (EP)
With Dust Cover	10.0330	70.0335

SURFACE MOUNT BASES



STANDARD PROFILE

# of Entries	Size of Entry		Standard Grey Coating		Black Coating (EP)	
	PG	NPT	PG Part #	NPT Part #	PG Part #	NPT Part #
2 Entries	16	1/2"	10.0380	10.0380 NP	70.0480	70.0480 NP
1 Entry	16	1/2"	10.0360	10.0360 NP	70.0470	70.0470 NP

HIGH PROFILE

# of Entries	Size of Entry		Standard Grey Coating		Black Coating (EP)	
	PG	NPT	PG Part #	NPT Part #	PG Part #	NPT Part #
2 Entries	21	3/4"	70.0462	70.0462 NP	70.0482	70.0482 NP
	29	1"	70.0464	70.0464 NP	70.0484	70.0484 NP
1 Entry	21	3/4"	70.0452	70.0452 NP	70.0472	70.0472 NP
	29	1"	70.0454	70.0454 NP	70.0474	70.0474 NP

DUST COVERS WITH ATTACHMENT STRING

Material: Thermoplastic Resin

Temperature: -40°C to 125°C



	Part #
Dust cover with single lever for HBE 10 Hoods	10.0486
Dust cover with single lever bolts for HBE 10 Panel Mount or Surface Mount Base/ Cable Coupler Hood	10.0487
Dust cover with double levers and gasket for HBE 10 Hoods	10.0485
Dust cover with double lever bolts for HBE 10 Panel Mount or Surface Mount Base/ Cable Coupler Hood	10.0470
Dust cover with double lever bolts and gasket for HBE 10 Hoods	10.0471

EPIC® CONNECTORS

HBVE 6 Plugs & Receptacles



SCREW TERMINATED INSERTS

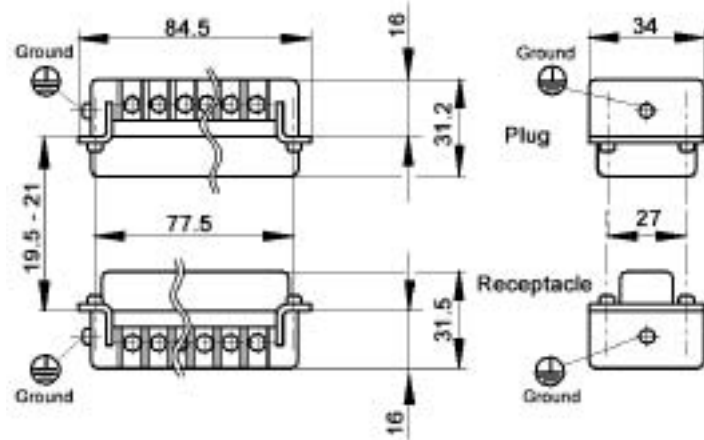
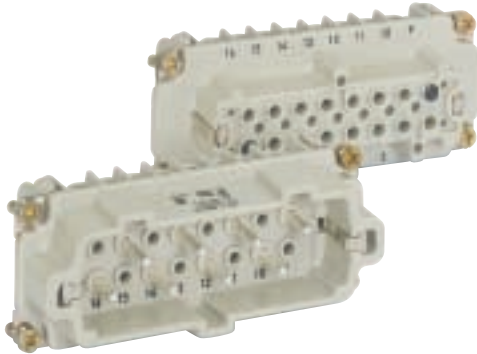

All dimensions are in mm.

View from cable side

Panel Cut-Out
(Insert Only)

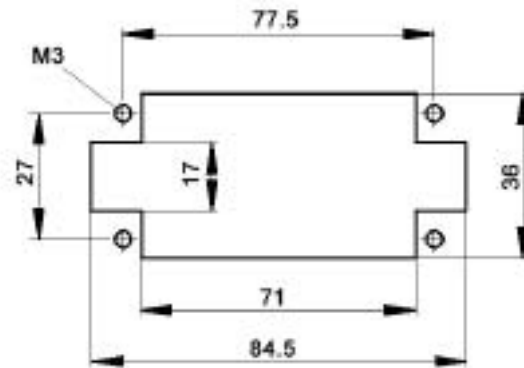
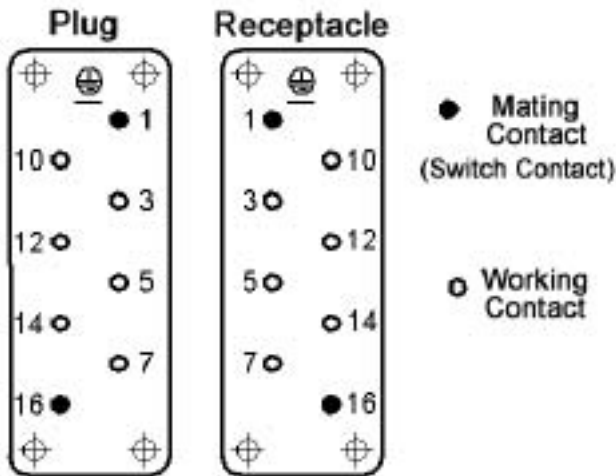

	Plug	Receptacle
Screw Termination with wire protection	10.239010	10.240010
Screw Termination without wire protection	10.239110	10.240110

MATING COMPONENTS

HBVE 6 Plugs & Receptacles fit into the EPIC® HBE 16 Housings. Following is a quick reference for the mating components is shown. Diagrams are located in the HBE Section of the catalog (Page 293). Please note that metric parts are available.

EPIC® CONNECTORS

HBE 16 Housings: Single Lever on Base for HBVE 6 Inserts



HOODS



STANDARD PROFILE

Position of Cable Entry	Size of Entry		Standard Grey Coating		Black Coating (EP)	
	PG	NPT	PG Part #	NPT Part #	PG Part #	NPT Part #
Top Entry	21	3/4"	10.0809	10.0809 NP	70.0990	70.0990 NP
	29	1"	10.0909	10.0909 NP	-	-
Side Entry	21	3/4"	10.0829	10.0829 NP	70.1090	70.1090 NP
	29	1"	10.0929	10.0929 NP	-	-

HIGH PROFILE

Position of Cable Entry	Size of Entry		Standard Grey Coating		Black Coating (EP)	
	PG	NPT	PG Part #	NPT Part #	PG Part #	NPT Part #
Top Entry	21	3/4"	70.0942	70.0942 NP	70.0992	70.0992 NP
	29	1"	70.0944	70.0944 NP	70.0994	70.0994 NP
Side Entry	21	3/4"	70.1042	70.1042 NP	70.1092	70.1092 NP
	29	1"	70.1044	70.1044 NP	70.1094	70.1094 NP

PANEL MOUNT BASES

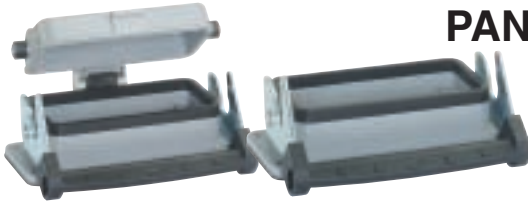

Description	Standard Grey Coating	Black Coating (EP)
Without Dust Cover	10.0729	70.0827
With Dust Cover	10.0739	70.0837

SURFACE MOUNT BASES



STANDARD PROFILE

# of Entries	Size of Entry		Standard Grey Coating		Black Coating (EP)	
	PG	NPT	PG Part #	NPT Part #	PG Part #	NPT Part #
2 Entries	21	3/4"	10.0759	10.0759 NP	70.1130	70.1130 NP
1 Entry	21	3/4"	10.0749	10.0749 NP	70.1120	70.1120 NP
2 Entries with dust cover	21	3/4"	10.0789	10.0789 NP	70.1170	70.1170 NP
	-	-	-	-	-	-
1 Entry with dust cover	21	3/4"	10.0769	10.0769 NP	70.1160	70.1160 NP
	-	-	-	-	-	-

HIGH PROFILE

# of Entries	Size of Entry		Standard Grey Coating		Black Coating (EP)	
	PG	NPT	PG Part #	NPT Part #	PG Part #	NPT Part #
2 Entries	21	3/4"	70.1112	70.1112 NP	70.1132	70.1132 NP
	29	1"	70.1114	70.1114 NP	70.1134	70.1134 NP
1 Entry	21	3/4"	70.1102	70.1102 NP	70.1122	70.1122 NP
	29	1"	70.1104	70.1104 NP	70.1124	70.1124 NP
2 Entries with dust cover	21	3/4"	70.1152	70.1152 NP	70.1172	70.1172 NP
	29	1"	70.1154	70.1154 NP	70.1174	70.1174 NP
1 Entry with dust cover	21	3/4"	70.1142	70.1142 NP	70.1162	70.1162 NP
	29	1"	70.1144	70.1144 NP	70.1164	70.1164 NP

CABLE COUPLER HOODS



Profile	Size of Entry		Standard Grey Coating		Black Coating (EP)	
	PG	NPT	PG Part #	NPT Part #	PG Part #	NPT Part #
Standard Profile	21	3/4"	10.0869	10.0869 NP	70.0930	70.0930 NP
	29	1"	10.0969	10.0969 NP	-	-
High Profile	21	3/4"	70.0922	70.0922 NP	70.0932	70.0932 NP
	29	1"	70.0924	70.0924 NP	70.0934	70.0934 NP

EPIC® CONNECTORS

HBE 16 Housings: Double Levers on Base for HBVE 6 Inserts



HOODS

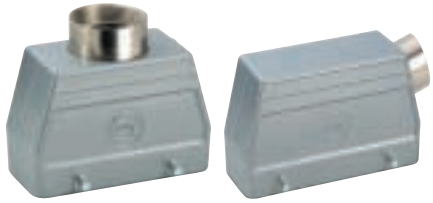

STANDARD PROFILE

Position of Cable Entry	Size of Entry		Standard Grey Coating		Black Coating (EP)	
	PG	NPT	PG Part #	NPT Part #	PG Part #	NPT Part #
Top Entry	21	3/4"	10.0800	10.0800 NP	70.1010	70.1010 NP
	29	1"	10.0900	10.0900 NP	-	-
Side Entry	21	3/4"	10.0820	10.0820 NP	70.1030	70.1030 NP
	29	1"	10.0920	10.0920 NP	-	-

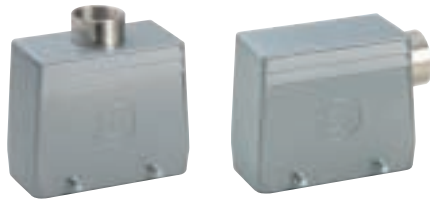

HIGH PROFILE

Position of Cable Entry	Size of Entry		Standard Grey Coating		Black Coating (EP)	
	PG	NPT	PG Part #	NPT Part #	PG Part #	NPT Part #
Top Entry	21	3/4"	70.1002	70.1002 NP	70.1012	70.1012 NP
	29	1"	70.1004	70.1004 NP	70.1014	70.1014 NP
Side Entry	21	3/4"	70.1022	70.1022 NP	70.1032	70.1032 NP
	29	1"	70.1024	70.1024 NP	70.1034	70.1034 NP

PANEL MOUNT BASES

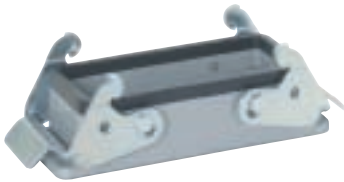

Description	Standard Grey Coating	Black Coating (EP)
Without Dust Cover	10.0720	70.0825

SURFACE MOUNT BASES



STANDARD PROFILE

# of Entries	Size of Entry		Standard Grey Coating		Black Coating (EP)	
	PG	NPT	PG Part #	NPT Part #	PG Part #	NPT Part #
2 Entries	21	3/4"	10.0750	10.0750 NP	70.0880	70.0880 NP
1 Entry	21	3/4"	10.0740	10.0740 NP	70.0870	70.0870 NP



HIGH PROFILE

# of Entries	Size of Entry		Standard Grey Coating		Black Coating (EP)	
	PG	NPT	PG Part #	NPT Part #	PG Part #	NPT Part #
2 Entries	21	3/4"	70.0862	70.0862 NP	70.0882	70.0882 NP
	29	1"	70.0864	70.0864 NP	70.0884	70.0884 NP
1 Entry	21	3/4"	70.0852	70.0852 NP	70.0872	70.0872 NP
	29	1"	70.0854	70.0854 NP	70.0874	70.0874 NP

CABLE COUPLER HOODS



Profile	Size of Entry		Standard Grey Coating		Black Coating (EP)	
	PG	NPT	PG Part #	NPT Part #	PG Part #	NPT Part #
Standard Profile	21	3/4"	10.0860	10.0860 NP	70.0910	70.0910 NP
	29	1"	10.0960	10.0960 NP	-	-
High Profile	21	3/4"	70.0902	70.0902 NP	70.0912	70.0912 NP
	29	1"	70.0904	70.0904 NP	70.0914	70.0914 NP

EPIC® CONNECTORS

HBE 16 Housings: Double Levers on Hood for HBVE 6 Inserts



HOODS

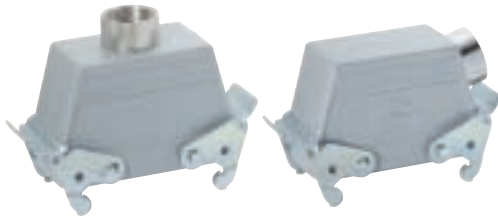

STANDARD PROFILE

Position of Cable Entry	Size of Entry		Standard Grey Coating		Black Coating (EP)	
	PG	NPT	PG Part #	NPT Part #	PG Part #	NPT Part #
Top Entry	21	3/4"	10.0810	10.0810 NP	70.1060	70.1060 NP
	29	1"	10.0910	10.0910 NP	-	-
Side Entry	21	3/4"	10.0830	10.0830 NP	70.1080	70.1080 NP
	29	1"	10.0930	10.0930 NP	-	-



HIGH PROFILE

Position of Cable Entry	Size of Entry		Standard Grey Coating		Black Coating (EP)	
	PG	NPT	PG Part #	NPT Part #	PG Part #	NPT Part #
Top Entry	21	3/4"	70.1052	70.1052 NP	70.1062	70.1062 NP
	29	1"	70.1054	70.1054 NP	70.1064	70.1064 NP
Side Entry	21	3/4"	70.1072	70.1072 NP	70.1082	70.1032 NP
	29	1"	70.1074	70.1074 NP	70.1084	70.1034 NP



PANEL MOUNT BASES

Description	Standard Grey Coating	Black Coating (EP)
Without Dust Cover	10.0731	-
With Dust Cover	10.0730	70.0835

SURFACE MOUNT BASES



# of Entries	Size of Entry		Standard Grey Coating		Black Coating (EP)	
	PG	NPT	PG Part #	NPT Part #	PG Part #	NPT Part #
2 Entries	21	3/4"	70.0960	70.0960 NP	70.0980	70.0980 NP
1 Entry	21	3/4"	10.0760	10.0760 NP	70.0970	70.0970 NP
2 Entries with dust cover	21	3/4"	70.0962	70.0962 NP	70.0982	70.0982 NP
	29	1"	70.0964	70.0964 NP	70.0984	70.0984 NP
1 Entry with dust cover	21	3/4"	70.0952	70.0952 NP	70.0972	70.0972 NP
	29	1"	70.0954	70.0954 NP	70.0974	70.0974 NP

DUST COVERS WITH ATTACHMENT STRING

Material: Thermoplastic Resin

Temperature: -40°C to 125°C



	Part #
Dust cover with single lever for HBE 16 Hoods	10.0886
Dust cover with single lever bolts for HBE 16 Panel Mount or Surface Mount Base/ Cable Coupler Hood	10.0887
Dust cover with double levers and gasket for HBE 16 Hoods	10.0885
Dust cover with double lever bolts for HBE 16 Panel Mount or Surface Mount Base/ Cable Coupler Hood	10.0870
Dust cover with double lever bolts and gasket for HBE 16 Hoods	10.0871

EPIC® CONNECTORS

HBVE 10 Plugs & Receptacles



SCREW TERMINATED INSERTS

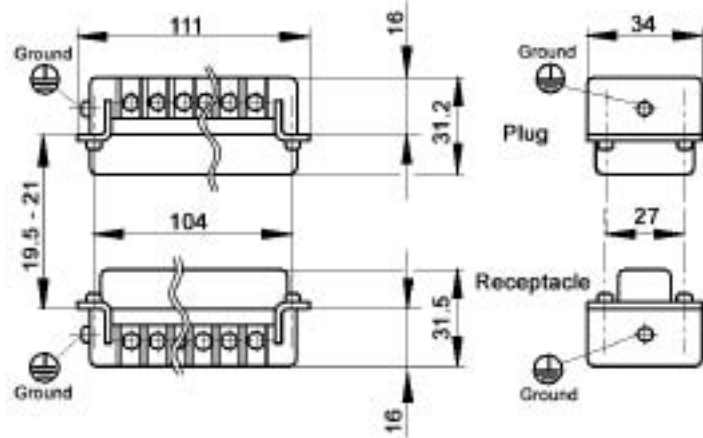
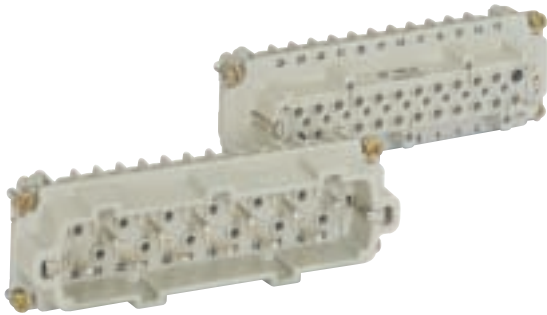

All dimensions are in mm.

View from cable side

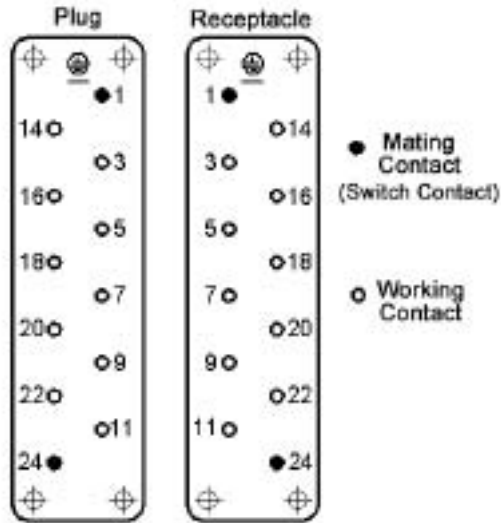

Panel Cut-Out
(Insert Only)

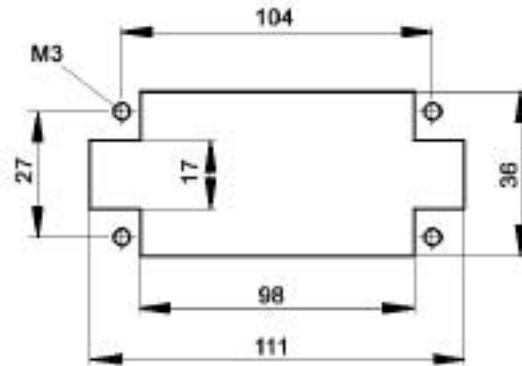

	Plug	Receptacle
Screw Termination with wire protection	10.270010	10.271010
Screw Termination without wire protection	10.270110	10.271110

MATING COMPONENTS

HBVE 10 Plugs & Receptacles fit into the EPIC® HBE 24 Housings. Following is a quick reference for the mating components is shown. Diagrams are located in the HBE Section of the catalog (Page 303). Please note that metric parts are available.

EPIC[®] CONNECTORS

HBE 24 Housings: Single Lever on Base for HBVE 10 Inserts



HOODS



STANDARD PROFILE

Position of Cable Entry	Size of Entry		Standard Grey Coating		Black Coating (EP)	
	PG	NPT	PG Part #	NPT Part #	PG Part #	NPT Part #
Top Entry	21	3/4"	10.1219	10.1219 NP	70.1490	70.1490 NP
	29	1"	10.1119	10.1119 NP	70.1492	70.1492 NP
Side Entry	21	3/4"	10.1139	10.1139 NP	70.1590	70.1590 NP
	29	1"	10.1239	10.1239 NP	70.1592	70.1592 NP

HIGH PROFILE

Position of Cable Entry	Size of Entry		Standard Grey Coating		Black Coating (EP)	
	PG	NPT	PG Part #	NPT Part #	PG Part #	NPT Part #
Top Entry	21	3/4"	70.1444	70.1444 NP	70.1494	70.1494 NP
	29	1"	70.1446	70.1446 NP	70.1496	70.1496 NP
Side Entry	21	3/4"	70.1544	70.1544 NP	70.1594	70.1594 NP
	29	1"	70.1546	70.1546 NP	70.1596	70.1596 NP

PANEL MOUNT BASES

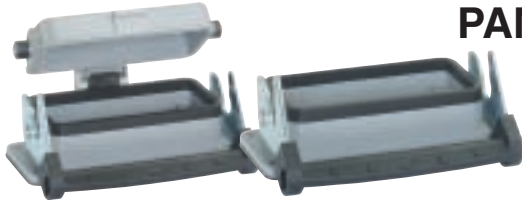

Description	Standard Grey Coating	Black Coating (EP)
Without Dust Cover	10.1029	70.1327
With Dust Cover	10.1039	70.1337

SURFACE MOUNT BASES



STANDARD PROFILE

# of Entries	Size of Entry		Standard Grey Coating		Black Coating (EP)	
	PG	NPT	PG Part #	NPT Part #	PG Part #	NPT Part #
2 Entries	21	3/4"	10.1059	10.1059 NP	70.1630	70.1630 NP
1 Entry	21	3/4"	10.1049	10.1049 NP	70.1620	70.1620 NP
2 with cover	21	3/4"	10.1099	10.1099 NP	70.1670	70.1670 NP
1 with cover	21	3/4"	10.1079	10.1079 NP	70.1660	70.1660 NP

HIGH PROFILE

# of Entries	Size of Entry		Standard Grey Coating		Black Coating (EP)	
	PG	NPT	PG Part #	NPT Part #	PG Part #	NPT Part #
2 Entries	21	3/4"	70.1612	70.1612 NP	70.1632	70.1632 NP
	29	1"	70.1614	70.1614 NP	70.1634	70.1634 NP
1 Entry	21	3/4"	70.1602	70.1602 NP	70.1622	70.1622 NP
	29	1"	70.1604	70.1604 NP	70.1624	70.1624 NP
2 Entries with dust cover	21	3/4"	70.1652	70.1652 NP	70.1672	70.1672 NP
	29	1"	70.1654	70.1654 NP	70.1674	70.1674 NP
1 Entry with dust cover	21	3/4"	70.1642	70.1642 NP	70.1662	70.1662 NP
	29	1"	70.1644	70.1644 NP	70.1664	70.1664 NP

CABLE COUPLER HOODS



Profile	Size of Entry		Standard Grey Coating		Black Coating (EP)	
	PG	NPT	PG Part #	NPT Part #	PG Part #	NPT Part #
Standard Profile	21	3/4"	10.1279	10.1279 NP	70.1430	70.1430 NP
	29	1"	10.1179	10.1179 NP	70.1432	70.1432 NP
High Profile	21	3/4"	70.1424	70.1424 NP	70.1434	70.1434 NP
	29	1"	70.1426	70.1426 NP	70.1436	70.1436 NP

EPIC® CONNECTORS

HBE 24 Housings: Double Levers on Base for HBVE 10 Inserts



HOODS

STANDARD PROFILE

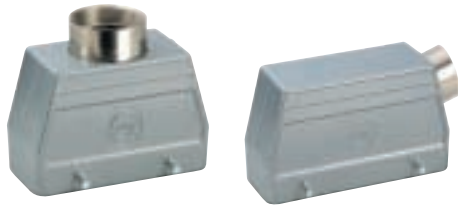

Position of Cable Entry	Size of Entry		Standard Grey Coating		Black Coating (EP)	
	PG	NPT	PG Part #	NPT Part #	PG Part #	NPT Part #
Top Entry	21	3/4"	10.1210	10.1210 NP	70.1510	70.1510 NP
	29	1"	10.1110	10.1110 NP	70.1512	70.1512 NP
Side Entry	21	3/4"	10.1130	10.1130 NP	70.1530	70.1530 NP
	29	1"	10.1230	10.1230 NP	70.1532	70.1532 NP

HIGH PROFILE

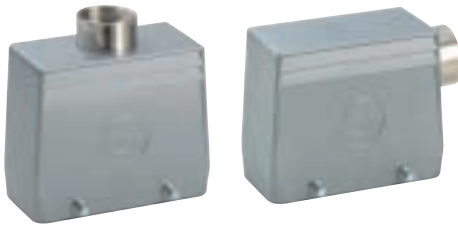

Position of Cable Entry	Size of Entry		Standard Grey Coating		Black Coating (EP)	
	PG	NPT	PG Part #	NPT Part #	PG Part #	NPT Part #
Top Entry	21	3/4"	70.1504	70.1504 NP	70.1514	70.1514 NP
	29	1"	70.1506	70.1506 NP	70.1516	70.1516 NP
Side Entry	21	3/4"	70.1524	70.1524 NP	70.1534	70.1534 NP
	29	1"	70.1526	70.1526 NP	70.1536	70.1536 NP

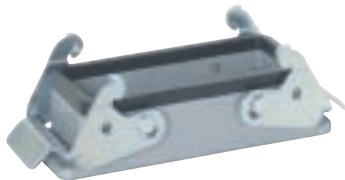

PANEL MOUNT BASES

Description	Standard Grey Coating	Black Coating (EP)
Without Dust Cover	10.1020	70.1325

SURFACE MOUNT BASES

STANDARD PROFILE



# of Entries	Size of Entry		Standard Grey Coating		Black Coating (EP)	
	PG	NPT	PG Part #	NPT Part #	PG Part #	NPT Part #
2 Entries	21	3/4"	10.1050	10.1050 NP	70.1380	70.1380 NP
1 Entry	21	3/4"	10.1040	10.1040 NP	70.1370	70.1370 NP

HIGH PROFILE



# of Entries	Size of Entry		Standard Grey Coating		Black Coating (EP)	
	PG	NPT	PG Part #	NPT Part #	PG Part #	NPT Part #
2 Entries	21	3/4"	70.1362	70.1362 NP	70.1382	70.1382 NP
	29	1"	70.1364	70.1364 NP	70.1384	70.1384 NP
1 Entry	21	3/4"	70.1352	70.1352 NP	70.1372	70.1372 NP
	29	1"	70.1354	70.1354 NP	70.1374	70.1374 NP



CABLE COUPLER HOODS

Profile	Size of Entry		Standard Grey Coating		Black Coating (EP)	
	PG	NPT	PG Part #	NPT Part #	PG Part #	NPT Part #
Standard Profile	21	3/4"	10.1270	10.1270 NP	70.1410	70.1410 NP
	29	1"	10.1170	10.1170 NP	70.1412	70.1412 NP
High Profile	21	3/4"	70.1404	70.1404 NP	70.1414	70.1414 NP
	29	1"	70.1406	70.1406 NP	70.1416	70.1416 NP

EPIC[®] CONNECTORS

HBE 24 Housings: Double Levers on Hood for HBVE 10 Inserts



HOODS



STANDARD PROFILE

Position of Cable Entry	Size of Entry		Standard Grey Coating		Black Coating (EP)	
	PG	NPT	PG Part #	NPT Part #	PG Part #	NPT Part #
Top Entry	21	3/4"	10.1220	10.1220 NP	70.1560	70.1560 NP
	29	1"	10.1120	10.1120 NP	70.1562	70.1562 NP
Side Entry	21	3/4"	10.1140	10.1140 NP	70.1580	70.1580 NP
	29	1"	10.1240	10.1240 NP	70.1582	70.1582 NP

HIGH PROFILE

Position of Cable Entry	Size of Entry		Standard Grey Coating		Black Coating (EP)	
	PG	NPT	PG Part #	NPT Part #	PG Part #	NPT Part #
Top Entry	21	3/4"	70.1554	70.1554 NP	70.1564	70.1564 NP
	29	1"	70.1556	70.1556 NP	70.1566	70.1566 NP
Side Entry	21	3/4"	70.1574	70.1574 NP	70.1584	70.1584 NP
	29	1"	70.1576	70.1576 NP	70.1586	70.1586 NP

PANEL MOUNT BASES



Description	Standard Grey Coating	Black Coating (EP)
With Dust Cover	10.1030	70.1335
Without Dust Cover	10.1031	-

SURFACE MOUNT BASES



# of Entries	Size of Entry		Standard Grey Coating		Black Coating (EP)	
	PG	NPT	PG Part #	NPT Part #	PG Part #	NPT Part #
2 Entries	21	3/4"	10.1090	10.1090 NP	70.1480	70.1480 NP
1 Entry	21	3/4"	10.1070	10.1070 NP	70.1470	70.1470 NP
2 Entries with dust cover	21	3/4"	70.1462	70.1462 NP	70.1482	70.1482 NP
	29	1"	70.1464	70.1464 NP	70.1484	70.1484 NP
1 Entry with dust cover	21	3/4"	70.1452	70.1452 NP	70.1472	70.1472 NP
	29	1"	70.1454	70.1454 NP	70.1474	70.1474 NP

DUST COVERS WITH ATTACHMENT STRING

Material: Thermoplastic Resin

Temperature: -40°C to 125°C



	Part #
Dust cover with single lever for HBE 24 Hoods	10.1186
Dust cover with single lever bolts for HBE 24 Panel Mount or Surface Mount Base/ Cable Coupler Hood	10.1187
Dust cover with double levers and gasket for HBE 24 Hoods	10.1195
Dust cover with double lever bolts for HBE 24 Panel Mount or Surface Mount Base/ Cable Coupler Hood	10.1180
Dust cover with double lever bolts and gasket for HBE 24 Hoods	10.1181